



Wellell Group

PRODUCT INFORMATION

universal hoists and active hoists
slings and accessories

#workgreen

www.slk-gmbh.de



content

4/5 universal hoists

- 6 SLK Carry 185 Eco
- 7 SLK Carry 185 Classic / Classic e
- 8 SLK Carry 185 Pro / Pro e
- 9 SLK Carry 185 Pro L / Pro L e
- 10 SLK Carry Compact

12/13 hybrid hoists

- 14 SLK Multy Universal / Universal e
- 15 SLK Multy Conversion Kit Active
- 16 SLK Multy Active / Active e
- 17 SLK Multy Conversion Kit Universal

18 active hoists

- 20 SLK Eazy-up

21 technical specifications universal hoists & active hoists

- 22/23 Technical Specifications Universal Hoists & Active Hoists

24/25 universal slings / active slings

- 26 SLK Universal Sling
- 27 SLK Universal Sling with Headrest
- 28 SLK Universal Bathroom Sling
- 29 SLK Universal Bathroom Sling with Headrest
- 30 SLK Quick Transfer and Toilet Sling
- 31 SLK Toilet Sling
- 32 SLK Hammock Universal Sling
- 33 SLK Hammock Bathroom Sling
- 34 SLK Hammock Seat Pan Sling
- 35 SLK Comfort Lying Sling
- 36 SLK Comfort Lying Bathroom Sling
- 37 SLK Back-Fix Sling
- 38 SLK Back-Fix Bathroom Sling
- 39 SLK Maxi Sling
- 40 SLK Active Sling
- 41 SLK Special Active Sling
- 42 SLK Special Active Sling with Seat Swing

43

size chart / overview

44

Size Chart Slings

45

Overview Slings

46

hoist accessories / slings accessories

47

SLK Hoist Scale

47

SLK Calibrated Hoist Scale

48

SLK Scales incl. Scale Adapter

48

SLK Charging Station

48

SLK Charging Station with Charger

48

SLK Wall-mounted Charging Station

49

SLK 2-Point Spreader Bar

49

SLK 4-Point Spreader Bar X

49

SLK 4-Point Spreader Bar H

50

SLK 8-Point Spreader Bar

51

SLK Impact Protector for Lifting Arm

51

SLK Velcro Headrest

51

SLK Adjustable Headrest Reinforced

52

SLK Extension Loops

53

SLK Weight Test Trolley up to 220 kg

54

SLK Test Trolley up to 440 kg

#workgreen

For these reasons you should use Universal Hoists

How many people are needed according to load handling regulation to reposition a patient?

According to national law, 4 nurses are required. Alternatively, a patient hoist can be used which is operated by only one nurse.

Universal Hoists have been used for decades in everyday nursing care to support caregivers. They can be used for home care, in care facilities and hospitals. Universal Hoists are used to pick up, transport and change the position of patients with mobility impairments due to illness or disability. With a suitable Sling, it is possible to move a patient safely and gently.

Advantages of a Universal Hoist

Advantages for the patient

- safe and gentle transfer
- gentle pick up and set down of the patient
- lifting from floor level possible
- electric spreading of the chassis (optional) adjustable

Advantages for the caregiver

- simple operation during transfer
- minimization of physical stress on the caregiver during transfer

universal hoists
**designed for use in facilities,
clinics and homecare**



SLK Carry 185 Eco

economical Universal Hoist for home care



SPECIFICATIONS	MANUAL SPREADING
length	118 cm (46.4")
total height	137 cm (54")
width	61 cm (24")
leg height	11 cm (4.3")
lifting height	81 - 203 cm (32" - 80")
turning radius	132 cm (52")
base expansion	51 - 94 cm (20" - 37")
weight	37 kg (81 lbs)

further details on page: 22-23

details

- max. patient weight: 185 kg (407 lbs)
- protects the back of the caregiver
- gentle pick up and set down of the patient
- lifting from floor level possible
- manual spreading
- high manoeuvrability in a small area
- Hook mount with spring safety device
- 360-degree rotation of the Spreader Bar in highest possible position
- foldable without tools / transportable

appropriate slings

- all SLK Slings (from page 25)

standard

- SLK 2-Point Spreader Bar

optional

- SLK 4-Point Spreader Bar X: 8060
- SLK 4-Point Spreader Bar H: 8064

Accessories from page 46

material

- powder coated steel
- ball-bearing swivel-castors

warranty

- According to our current service guidelines

medical aid number: (Germany) 22.40.01.0098 (manual)
article-ID 8000 manual spreading

SLK Carry 185 Classic / Classic e

ideal solution for home care



SPECIFICATIONS	MANUAL SPREADING	ELECTRIC SPREADING
length	118 cm (46.4")	118 cm (46.4")
total height	137 cm (54")	137 cm (54")
width	61 cm (24")	61 cm (24")
leg height	11 cm (4.3")	11 cm (4.3")
lifting height	81 - 203 cm (31.8" - 80")	81 - 203 cm (32" - 80")
turning radius	132 cm (52")	132 cm (52")
base expansion	51 - 94 cm (20" - 37")	51 - 94 cm (20" - 37")
weight	37 kg (81 lbs)	38 kg (84 lbs)

further details on page: 22-23

details

- max. patient weight: 185 kg (407 lbs)
- protects the back of the caregiver
- gentle pick up and set down of the patient
- lifting from floor level possible
- electric spreading (optional) adjustable
- high manoeuvrability in a small area
- Hook mount with spring safety device
- 360-degree rotation of the Spreader Bar in highest possible position
- comfort-control with display and readout function
- handling via control box possible
- soft-start / soft-stop
- high battery power
- foldable without tools / transportable
- standard mast and chassis are removable without tools

appropriate slings

- all SLK Slings (from page 25)

standard

- SLK 2-Point Spreader Bar

optional

- SLK 4-Point Spreader Bar X: 8060
- SLK 4-Point Spreader Bar H: 8064

Accessories from page 46

material

- powder coated steel
- ball-bearing swivel-castors

warranty

- According to our current service guidelines

ALSO AVAILABLE WITH e-CHASSIS...

medical aid number: (Germany) 22.40.01.0099 (manual), 22.40.01.0110 (electric)
article-ID 8002 manual spreading, 8003 electric spreading

SLK Carry 185 Pro / Pro e

Universal Hoist designed for use in facilities and clinics



MADE
IN
GERMANY

LBS
407



Chassis with comfort castors

SPECIFICATIONS	MANUAL SPREADING	ELECTRIC SPREADING
length	115 cm (45.3")	115 cm (45.3")
total height	137 cm (54")	137 cm (54")
width	64 cm (26")	64 cm (26")
leg height	11 cm (4.3")	11 cm (4.3")
lifting height	81 - 203 cm (32" - 80")	81 - 203 cm (32" - 80")
turning radius	130 cm (51")	130 cm (51")
base expansion	51 - 94 cm (20" - 37")	51 - 94 cm (20" - 37")
weight	38 kg (84 lbs)	39 kg (86 lbs)

further details on page: 22-23

details

- max. patient weight: 185 kg (407 lbs)
- protects the back of the caregiver
- gentle pick up and set down of the patient
- lifting from floor level possible
- electric spreading (optional) adjustable
- high manoeuvrability in a small area
- Hook mount with spring safety device
- 360-degree rotation of the Spreader Bar in highest possible position
- comfort-control with display and readout function
- handling via control box possible
- soft-start / soft-stop
- high battery power
- foldable without tools / transportable
- standard mast and chassis are removable without tools

appropriate slings

- all SLK Slings (from page 25)

standard

- SLK 2-Point Spreader Bar

optional

- SLK 4-Point Spreader Bar X: 8060
- SLK 4-Point Spreader Bar H: 8064

Accessories from page 46

material

- powder coated steel
- ball-bearing, smooth-running comfort-castors with high-quality plastic housing

warranty

- According to our current service guidelines

ALSO AVAILABLE WITH e-CHASSIS...

medical aid number: (Germany) 22.40.01.0100 (manual), 22.40.01.0108 (electric)
article-ID 8004 manual spreading, 8005 electric spreading

SLK Carry 185 Pro L / Pro L e

Universal Hoist with extra low chassis



MADE
IN
GERMANY

LBS
407



Especially low chassis with comfort castors

SPECIFICATIONS	MANUAL SPREADING	ELECTRIC SPREADING
length	115 cm (45.3")	115 cm (45.3")
total height	135 cm (53")	135 cm (53")
width	64 cm (26")	64 cm (26")
leg height	9 cm (3.5")	9 cm (3.5")
lifting height	79 - 201 cm (31" - 79")	79 - 201 cm (31" - 79")
turning radius	130 cm (51")	130 cm (51")
base expansion	51 - 94 cm (20" - 37")	51 - 94 cm (20" - 37")
weight	38 kg (84 lbs)	39 kg (86 lbs)

Further details on page: 22-23

details

- max. patient weight: 185 kg (407 lbs)
- protects the back of the caregiver
- gentle pick up and set down of the patient
- lifting from floor level possible
- electric spreading (optional) adjustable
- high manoeuvrability in a small area
- particularly low front underride height of: 88 mm
- Hook mount with spring safety device
- 360-degree rotation of the Spreader Bar in highest possible position
- comfort-control with display and readout function
- handling via control box possible
- soft-start / soft-stop
- high battery power
- foldable without tools / transportable
- standard mast and chassis are removable without tools

appropriate slings

- all SLK Slings (from page 25)

standard

- SLK 2-Point Spreader Bar

optional

- SLK 4-Point Spreader Bar X: 8060
- SLK 4-Point Spreader Bar H: 8064

Accessories from page 46

material

- powder coated steel
- ball-bearing, smooth-running comfort-castors with high-quality plastic housing

warranty

- According to our current service guidelines

ALSO AVAILABLE WITH e-CHASSIS...

medical aid number: (Germany) 22.40.01.0101 (manual), 22.40.01.0109 (electric)
article-ID 8006 manual spreading, 8007 electric spreading

SLK Carry Compact

Universal Hoist with short chassis for narrow living spaces



MADE
IN
GERMANY

LBS
352



especially compact universal hoist

SPECIFICATIONS	MANUAL SPREADING
length	103 cm (40.5")
total height	124 cm (50")
width	56 cm (22")
leg height	8,5 cm (3.4")
lifting height	81 - 175 cm (32" - 69")
turning radius	115 cm (45")
base expansion	45 - 78 cm (17.7" - 30.7")
weight	33 kg (73 lbs)

further details on page: 22-23

details

- max. patient weight: 160 kg (352 lbs)
- for children and small patients up to 1,70 m (67")
- protects the back of the caregiver
- gentle pick up and set down of the patient
- lifting from floor level possible
- adjustable chassis spreading
- easy to use in narrow spaces and doors
- high manoeuvrability in a small area
- particularly low front ground clearance of 83 mm
- Hook mount with spring safety device
- 360-degree rotation of the Spreader Bar in highest possible position
- comfort-control with display and readout function
- handling via control box possible
- soft-start / soft-stop
- high battery power / Li-Ion battery
- foldable without tools / transportable
- standard mast and chassis are removable without tools

medical aid number: (Germany) 22.40.01.0111
article-ID 8014 manual spreading

appropriate slings

- all SLK Slings (from page 25)

standard

- SLK 2-Point Spreader Bar Compact H

optional

- SLK 4-Point Spreader Bar H: 8064

Accessories from page 46

material

- powder coated steel
- high quality smooth running plastic housing castors

warranty

- According to our current service guidelines

WHAT WERE WE THINKING?

Here are a few USPs of our SLK Universal Hoists!

Profile



Dieter Fürst
CAD Designer

A master mechanical engineer and mechanical technician by training, I have been working as a product developer in the field of medical aids / medical products since 2007 and have already developed patient hoists and care beds to market maturity for several manufacturers. Working as a design engineer in automotive manufacturing automation and two years working for a medical device drive manufacturer rounded off my experience until I joined SLK in 2016. This is the right place for development work and innovation. With our team we have already developed several successful hoist models and it is a pleasure to be able to expand our hoist portfolio step by step.

1. CENTERING OF THE STANDARD MAST



Patient hoist masts should often be foldable so that the product can be easily transported. At the same time, the mast and chassis should be easily removable without the use of tools. The requirement during use, on the other hand, is for the two parts to be connected as rigidly as possible. To achieve this, we came up with a locking device for the standard mast with a centring piece. This means that the mast is fixed to the chassis without any play. We have protected this invention by means of a German utility model.

2. MAXIMUM LOAD 185 KG / 407 LBS



The fact that people are becoming heavier and heavier is also reflected in everyday care. That is why we have developed the SLK Carry hoist family in such a way that we can allow the high maximum load of 185 kg. This covers more than 90% of the weights of patients. Therefore, there is no need to purchase an additional hoist, except for real heavy-duty care.

3. TELESCOPIC STANDARD MAST

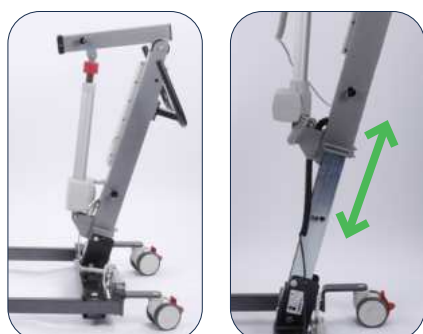

The telescopic standard mast turns the Multy into a hybrid hoist. It allows the Multy to be used as an active hoist and universal hoist without any restrictions and with an optimal height of the pivot point depending on the type of application. The height difference between the top and bottom position is 340 mm. For an upright raising procedure, the lowest possible pivot point is needed to be able to raise persons with residual mobility upright, while for a transfer using a universal hoist, the highest possible pivot point is needed.

These are the reasons for using Hybrid Hoists

The SLK Multy is a modular hybrid hoist that can be set up in two ways: As an Active Hoist and as a Universal Hoist. This is done by attaching an appropriate lifting arm and optionally using a foot-board with a shin support. The idea behind this is to provide our customers with a single hoist that can be used as a very well-functioning active hoist while the patient is still mobile. As required or if the patient's mobility decreases later on, the same hoist can be converted into a fully-fledged Universal Hoist / Patient Hoist in just a few steps. The SLK Multy Conversion Kit Active and the SLK Multy Conversion Kit Universal are available for this purpose. This eliminates the need to purchase a second hoist or to purchase a new hoist.

The advantages of a Hybrid Hoist

The advantages for the patient

- Quick conversion from an active hoist to a universal hoist and vice versa
- Safe and careful transfer
- Active Hoists provide support in therapy, in maintaining or increasing mobility and independence
- With their features, active hoists are beneficial for the stabilisation of the cardiovascular system
- Active Hoists provide an improvement in body sensation and bowel function
- Active Hoists positively influence the strengthening of bones, joints and cartilage and the careful lifting and setting down of the patient
- Picking up people from the ground possible, electrically (optional) adjustable chassis spreading

The advantages for the caregiver

- Simple operation during the transfer
- Minimization of the physical strain on the care assistant during the transfer

hybrid hoists
**designed for use in facilities,
clinics and homecare**



SLK Multy Universal / Multy Universal e

Universal Hoist convertible to Active Hoist



SLK Multy Conversion Kit Active

SPECIFICATIONS	MANUAL SPREADING	ELECTRIC SPREADING
length	118 cm (46.4")	118 cm (46.4")
total height	137 cm (54")	137 cm (54")
width	61 cm (24")	61 cm (24")
leg height	11 cm (4.3")	11 cm (4.3")
lifting height	81 - 203 cm (32" - 80")	81 - 203 cm (32" - 80")
turning radius	132 cm (52")	132 cm (52")
base expansion	51 - 94 cm (20" - 37")	51 - 94 cm (20" - 37")
weight	37 kg (81 lbs)	38 kg (84 lbs)

Further details on page: 22-23

details

- max. patient weight: 185 kg (407 lbs)
- protects the back of the caregiver
- gentle pick up and set down of the patient
- lifting from floor level possible
- electric spreading (optional) adjustable
- high manoeuvrability in a small area
- telescopic stand mast
- Hook mount with spring safety device
- 360-degree rotation of the Spreader Bar in highest possible position
- comfort-control with display and readout function
- handling via control box possible
- soft-start / soft-stop
- high battery power
- foldable without tools / transportable
- standard mast and chassis are removable without tools

appropriate slings

- all SLK Slings (from page 25)

standard

- SLK 2-Point Spreader Bar

optional

- SLK 4-Point Spreader Bar X: 8060
- SLK 4-Point Spreader Bar H: 8064
- SLK Multy Conversion Kit Active: 8011

Accessories from page 46

material

- powder coated steel
- ball-bearing, smooth-running comfort-castors with high-quality plastic housing

warranty

- According to our current service guidelines

ALSO AVAILABLE WITH e-CHASSIS...

medical aid number: (Germany) 22.40.01.0100 (manuell), 22.40.01.0112 (electric)
article-ID 8009 manual spreading, 8013 electric spreading

SLK Multy Conversion Kit Active

for SLK Multy Universal / Multy Universal e



2 IN 1

MADE
IN
GERMANY

LBS
407



SLK Multy Conversion Kit Active

The base of the Hybrid Hoist is the same for both versions.

By using attachments (Conversion Kits) the hoist can be converted to an Universal Hoist or an Active Hoist.

This Conversion Kit transforms the SLK Multy Hybrid Hoist (Universal Hoist) into a Active Hoist.

SLK Multy Conversion Kit Active

- footboard
- shin pads
- Active lifting arm



Height adjustable mast!
For setting the optimal
pivot point of both hoist types!

article-ID 8011

SLK Multy Active / Multy Active e

Active Hoist convertible to Universal Hoist



MADE
IN
GERMANY

LBS
407



SLK Multy Universal Conversion Kit

SPECIFICATIONS	MANUAL SPREADING	ELECTRIC SPREADING
length	118 cm (46.4")	118 cm (46.4")
total height	105 cm (42")	105 cm (42")
width	61 cm (24")	61 cm (24")
leg height	11 cm (4.3")	11 cm (4.3")
lifting height	85 - 163 cm (33" - 64")	85 - 163 cm (33" - 64")
turning radius	132 cm (51.5")	132 cm (51.5")
base expansion	51 - 94 cm (20" - 37")	51 - 94 cm (20" - 37")
weight	40 kg (88 lbs)	41 kg (90 lbs)

further details on page: 22-23

details

- max. patient weight: 185 kg (407 lbs)
- protects the back of the caregiver
- easier standing up due to particularly deep footboard
- easy transfer through active belt with seat swing/butt support (optional)
- safe transfer even in standing position
- Therapy-supporting, for the preservation or increase mobility
- electric spreading (optional) adjustable
- high manoeuvrability in a small area
- telescopic stand mast
- height adjustable shin pad
- comfort-control with display and readout function
- handling via control box possible
- soft-start / soft-stop
- high battery power
- foldable without tools / transportable
- standard mast and chassis are removable without tools

appropriate slings

- all SLK Active Slings (from page 40)

standard

- SLK Multy shin pad

optional

- SLK Narrow Calf Band: 8094
- SLK Multy Conversion Kit Universal: 8010

Accessories from page 46

material

- powder coated steel
- ball-bearing, smooth-running comfort-castors with high-quality plastic housing

warranty

- According to our current service guidelines

ALSO AVAILABLE WITH e-CHASSIS...

medical aid number: (Germany) 22.40.01.1001 (manual), 22.40.01.1027 (electric)
article-ID 8008 manual spreading, 8012 electric spreading

SLK Multy Conversion Kit Universal

for SLK Multy Active / Multy Active e



2 IN 1

MADE
IN
GERMANY

LBS
407



SLK Multy Conversion Kit Universal

The base of the Hybrid Hoist is the same for both versions.

By using attachments (Conversion Kits) the hoist can be converted to an Universal Hoist or an Active Hoist.

This Conversion Kit transforms the SLK Multy Hybrid Hoist (Active Hoist) into a Universal Hoist.

SLK Multy Conversion Kit Universal

- Universal lifting arm
- SLK 2-Point Spreader Bar



Height adjustable mast!
For setting the optimal
pivot point of both hoist types!

article-ID 8010

These are the reasons for using Active Hoists

Active Hoists make a valuable contribution to being able to change positions quickly and easily in the event of incipient mobility impairment. This also helps to preserve the dignity of the patient when discreetly using the toilet. The prerequisite for the use of active hoists is sufficient residual mobility of the patient and the use of the correct active sling.

The advantages for the patient

- Safe and careful transfer
- Active Hoists provide support in therapy, in maintaining or increasing mobility and independence
- With their features, active hoists are beneficial for the stabilisation of the cardiovascular system
- Active Hoists provide an improvement in body sensation and bowel function
- Active Hoists positively influence the strengthening of bones, joints and cartilage

The advantages for the caregiver

- Simple operation during the transfer
- Minimization of the physical strain on the caregiver during the transfer

active hoists
**designed for use in facilities,
clinics and homecare**

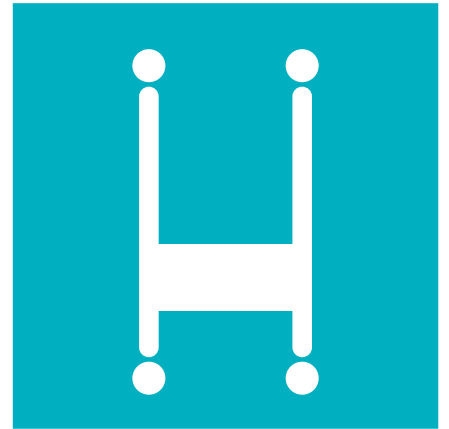
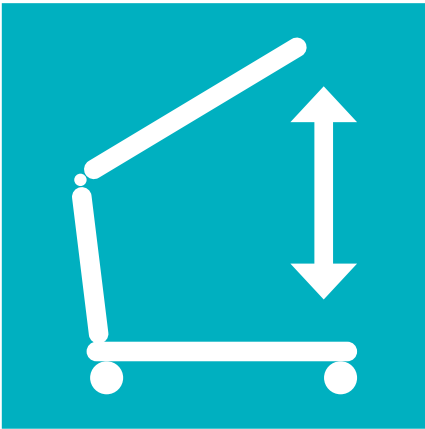

SLK Eazy-up

The Active Hoist with fixed, particularly low chassis for driving under the seat



ball-bearing dual-castors



optional Calf Band

SPECIFICATIONS	FIXED CHASSIS	MANUAL SPREADING
length	99 cm (39")	112 cm (44")
total height	114 cm (45")	115 cm (45.2")
width	58 cm (22")	58 cm (22")
leg height	6,6 cm (2.5")	9 cm (3.5")
lifting height	90 - 159 cm (35.4" - 62.5")	90 - 159 cm (35.4" - 62.5")
turning radius	90 cm (35.4")	114 cm (45")
base expansion		46 - 78 cm (18" - 31")
weight	34 kg (75 lbs)	37 kg (81 lbs)

details

- max. patient weight: 160 kg (352 lbs)
- easy to use in narrow spaces and doors
- high manoeuvrability in a small area
- protects the back of the caregiver
- easier standing up due to particularly deep footboard
- Adapted to the natural get up movement
- safe transfer even in standing position
- Therapy-supporting, for the preservation or increase mobility
- pluggable mast
- standard mast and chassis are removable without tools

appropriate slings

- SLK Active Sling Eco (size M/L)
- SLK Active Sling (size S - XXL)
- SLK Special Active Sling (size S - L)
- SLK Special Active Sling with Seat Swing (size S - XXL)

standard

- SLK Shin Pad

optional

- SLK Narrow Calf Band: 8094

material

- powder coated steel
- ball-bearing dual-castors

warranty

- According to our current service guidelines

medical aid number: (Germany) 22.40.01.1050 (fixed chassis), 22.40.01.1049 (manual spreading)
article-ID 8017 fixed chassis, 8016 manual spreading

technical specifications
universal hoists / active hoists

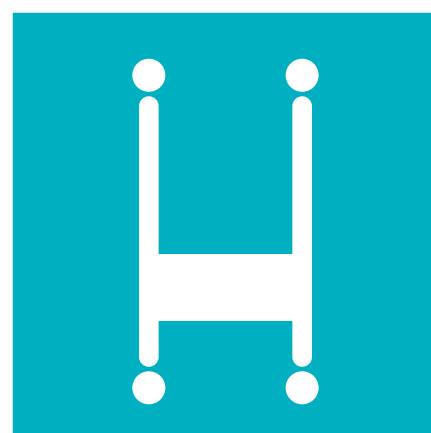

Technical Specifications

Universal Hoists / Active Hoists

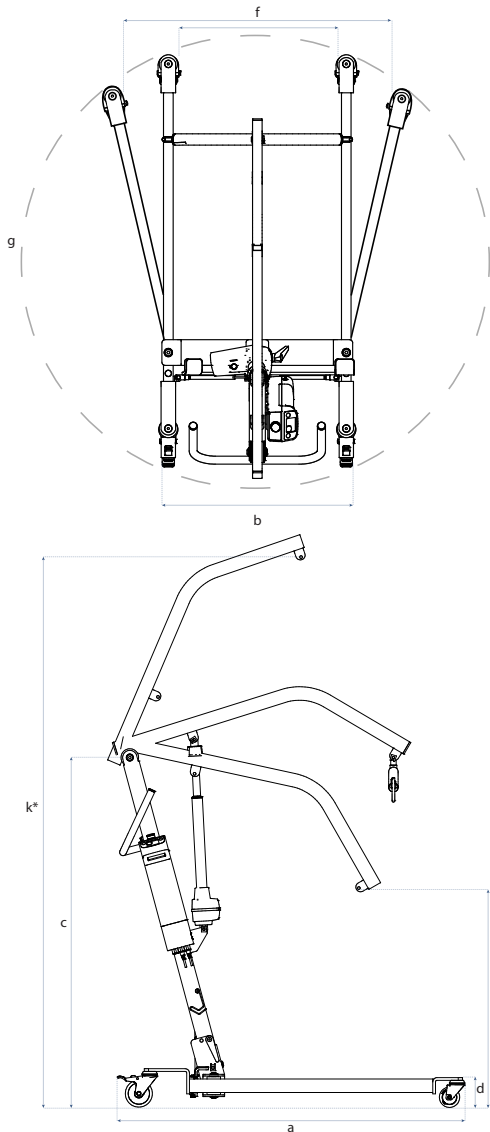

	length a	width b	total height c
SLK Carry 185 Eco			
manual spreading	118 (46.4")	61 (24")	137 (54")
SLK Carry 185 Classic / e			
manual spreading	118 (46.4")	61 (24")	137 (54")
electric spreading	118 (46.4")	61 (24")	137 (54")
SLK Carry 185 Pro / e			
manual spreading	115 (45.3")	64 (26")	137 (54")
electric spreading	115 (45.3")	64 (26")	137 (54")
SLK Carry 185 Pro L / e			
manual spreading	115 (45.3")	64 (26")	135 (53")
electric spreading	115 (45.3")	64 (26")	135 (53")
SLK Multy Universal / e			
manual spreading	118 (46.4")	61 (24")	137 (54")
electric spreading	118 (46.4")	61 (24")	137 (54")
SLK Carry Compact			
manual spreading	103 (40.5")	56 (22")	124 (50")
SLK Multy Active / e			
manual spreading	118 (46.4")	61 (24")	105 (42")
electric spreading	118 (46.4")	61 (24")	105 (42")
SLK Eazy-up fix / flex			
fixed chassis	99 (39")	58 (22")	114 (45")
manual spreading	112 (44")	58 (22")	115 (45.2")

*image DIN EN ISO 10535:2007-04

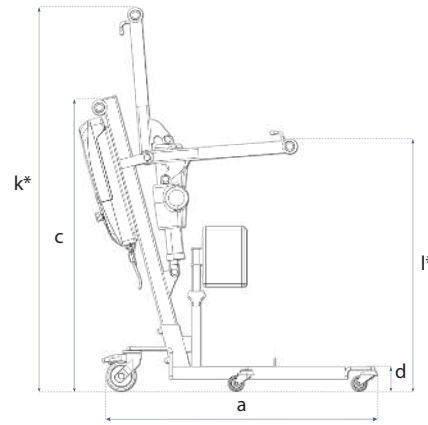
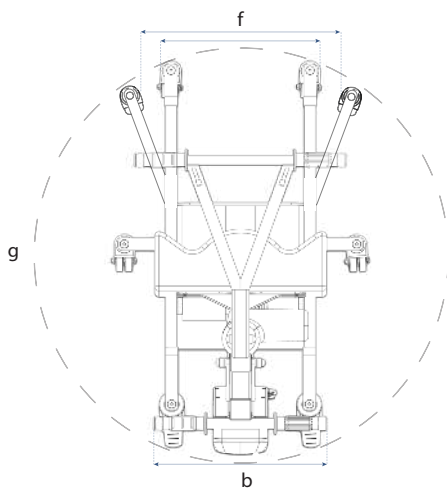

lifting height on top k*	height of feet d	lifting height below i*	base expansion f	turning radius g	total weight h	max. patient weight i
203 (80")	11 (4.3")	81 (32")	51 - 94 (20"-37")	132 (52")	37 kg (81 lbs)	185 kg (407 lbs)
203 (80")	11 (4.3")	81 (32")	51 - 94 (20"-37")	132 (52")	37 kg (81 lbs)	185 kg (407 lbs)
203 (80")	11 (4.3")	81 (32")	51 - 94 (20"-37")	132 (52")	38 kg (84 lbs)	185 kg (407 lbs)
203 (80")	11 (4.3")	81 (32")	51 - 94 (20"-37")	130 (51")	38 kg (84 lbs)	185 kg (407 lbs)
203 (80")	11 (4.3")	81 (32")	51 - 94 (20"-37")	130 (51")	39 kg (86 lbs)	185 kg (407 lbs)
201 (79")	9 (3.5")	79 (31")	51 - 94 (20"-37")	130 (51")	38 kg (84 lbs)	185 kg (407 lbs)
201 (79")	9 (3.5")	79 (31")	51 - 94 (20"-37")	130 (51")	39 kg (86 lbs)	185 kg (407 lbs)
203 (80")	11 (4.3")	81 (32")	51 - 94 (20"-37")	132 (52")	37 kg (81 lbs)	185 kg (407 lbs)
203 (80")	11 (4.3")	81 (32")	51 - 94 (20"-37")	132 (52")	38 kg (84 lbs)	185 kg (407 lbs)
175 (69")	8,5 (3.4")	81 (32")	45 - 78 (17.7"-30.7")	115 (45")	33 kg (73 lbs)	160 kg (352 lbs)
163 (64")	11 (4.3")	85 (33")	51 - 94 (20"-37")	132 (52")	40 kg (88 lbs)	185 kg (407 lbs)
163 (64")	11 (4.3")	85 (33")	51 - 94 (20"-37")	132 (52")	41 kg (90 lbs)	185 kg (407 lbs)
159 (35.4")	6,6 (2.5")	90 (35.4")		90 (35.4")	34 kg (75 lbs)	160 kg (352 lbs)
159 (35.4")	9 (3.5")	90 (35.4")	46 - 78 (18"-31")	114 (45")	37 kg (81 lbs)	160 kg (352 lbs)

Quality, Comfort and Safety are our priorities

In the development of our products, special emphasis is placed on therapeutic effectiveness and user-friendliness. For this reason, our hoist slings are specially tailored to the individual needs of patients.

We offer individual solution concepts for children, adults, light or heavy patients, in the homecare sector, in nursing institutions or clinics.

The SLK hoist slings are characterised by their first-class quality and user-friendliness. High-quality materials and professional workmanship ensure a high load capacity of up to 320 kg. In addition, the belts are washable up to a temperature of 70 °C and thus comply with the generally applicable hygiene standards.

The sling loops are colour-coded. This colour coding makes it possible to adjust the hoist sling to the patient more quickly and safely. The different coloured sling edges ensure quick recognition of the sizes. All SLK hoist slings are also suitable for use with hoists from other manufacturers in accordance with the current compatibility declaration. You can find the download for this on our website.

Download the current compatibility list from our website under Download.

Download! www.slk-gmbh.de

slings
universal slings / active slings

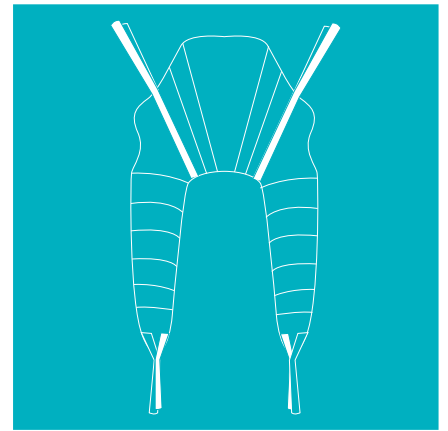
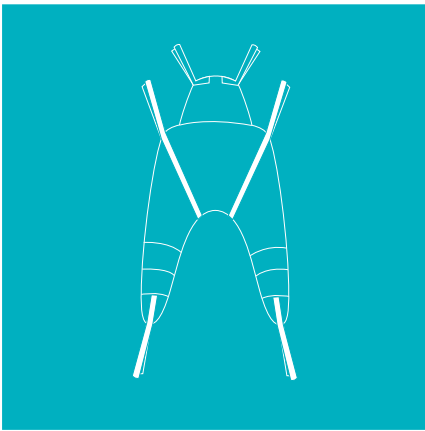

SLK Universal Sling

Universal Sling for general application

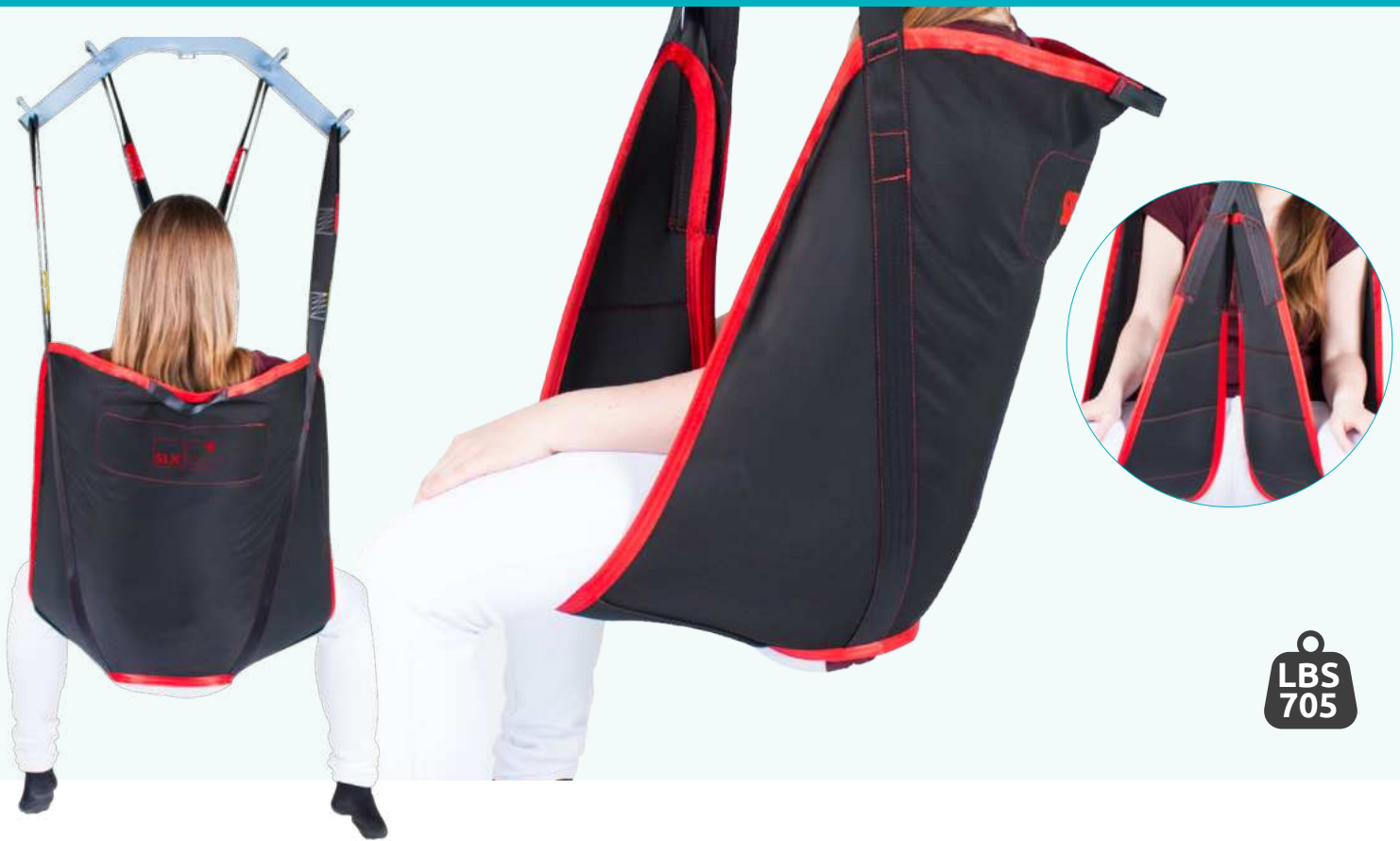

LBS
705

details

- max. patient weight: 320 kg (705 lbs)
- for safe transfer of the patient and lifting from ground level
- ensures a pleasant skin climate during continuous use
- also available in children's sizes (from size XXS)

sizes / article ID

KIDS	KIDS	
XXS	XS	S
5221	5222	5113
M	L	XL
5114	5115	5116
XXL	3XL	4XL
5117	5208	5209

Universal Hoists

- all SLK Universal Hoists
- also suitable for hoists of other producers according to our current declaration of conformity (download from our website)

optional

- SLK Velcro Headrest: 5118
- SLK Extension Loops: 5719

material / service

- Polyester-Jersey
- washable up to 70 °C (158 °F)

warranty

- According to our current service guidelines

settlement item no: 22.40.04.0001

SLK Universal Sling with Headrest

Universal Sling for general application with Headrest

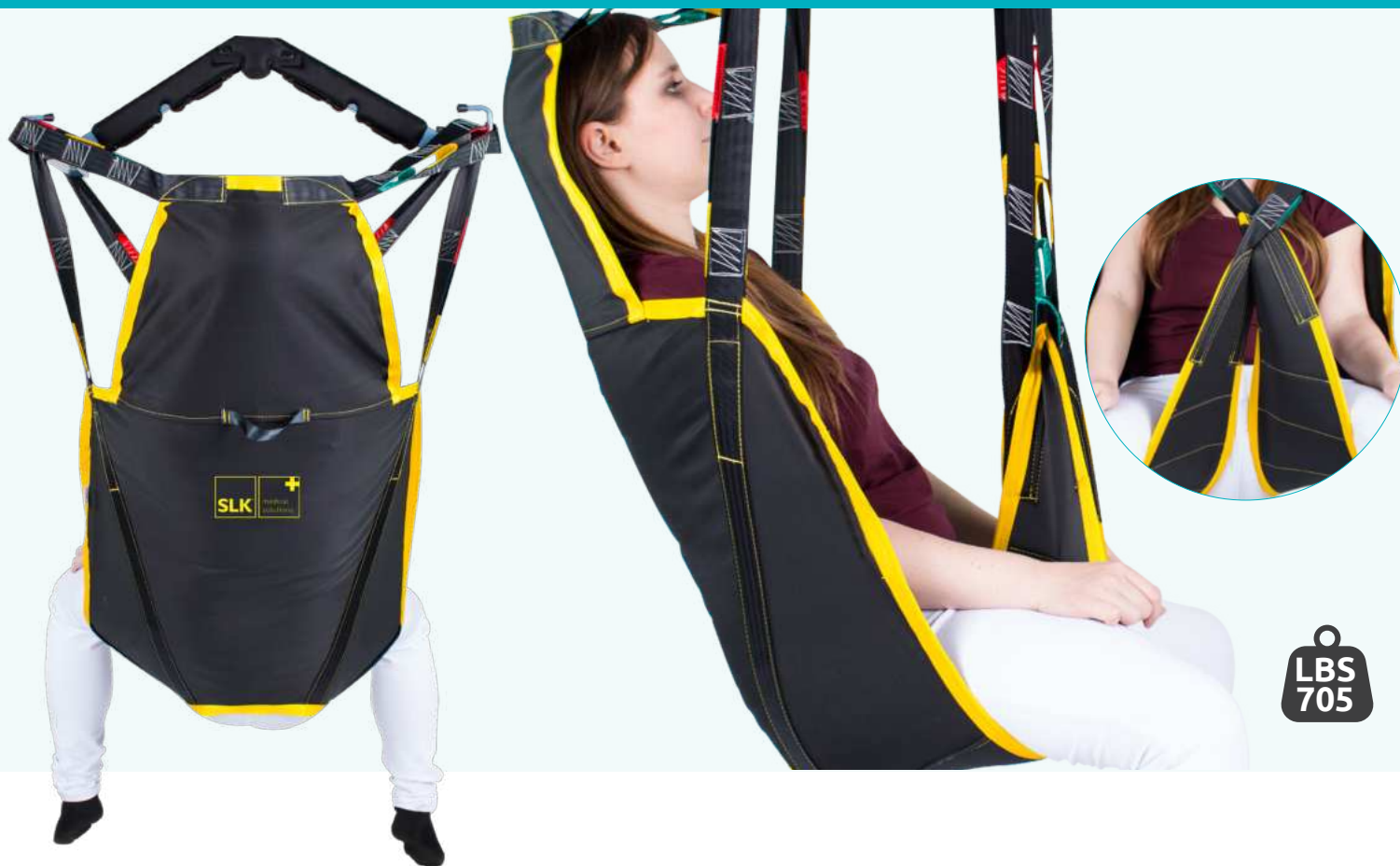

LBS
705

details

- max. patient weight: 320 kg (705 lbs)
- snug Universal Sling with integrated Headrest to stabilize the head
- ensures a pleasant skin climate during continuous use
- also available in children's sizes (from size XXS)

sizes / article ID

KIDS

XXS
5225

KIDS

XS
5226

S
5119

M
5120

L
5121

XL
5122

XXL
5123

Universal Hoists

- all SLK Universal Hoists
- also suitable for hoists of other producers according to our current declaration of conformity (download from our website)

optional

- SLK Extension Loops: 5719

material / service

- Polyester-Jersey
- washable up to 70 °C (158 °F)

warranty

- According to our current service guidelines

settlement item no: 22.40.04.0001

SLK Universal Bathroom Sling

Bathing Sling

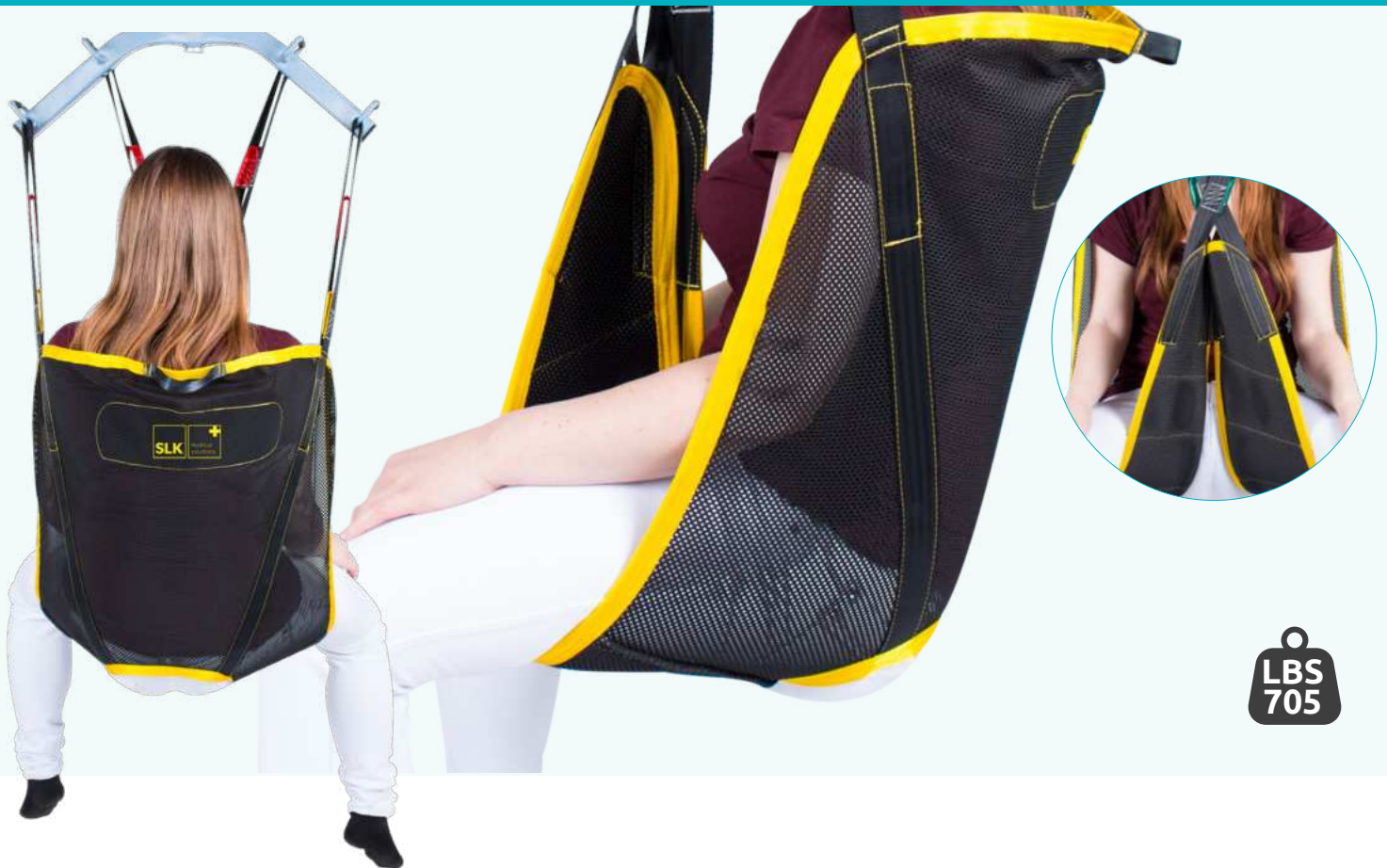

details

- max. patient weight: 320 kg (705 lbs)
- fast drying material
- a net made of polyester jersey enables fast and easy drainage of water
- ensures a pleasant skin climate during continuous use
- also available in children's sizes (from size XXS)

sizes / article ID

KIDS		KIDS	
XXS 5229	XS 5230	S 5124	
M 5125	L 5126	XL 5127	
XXL 5128	3XL 5210	4XL 5211	

Universal Hoists

- all SLK Universal Hoists
- also suitable for hoists of other producers according to our current declaration of conformity (download from our website)

optional

- SLK Velcro Headrest: 5118
- SLK Extension Loops: 5719

material / service

- Polyester-Jersey
- washable up to 70 °C (158 °F)

warranty

- According to our current service guidelines

settlement item no: 22.40.04.0001

SLK Universal Bathroom Sling with Headrest

Universal Sling for bathing with Headrest

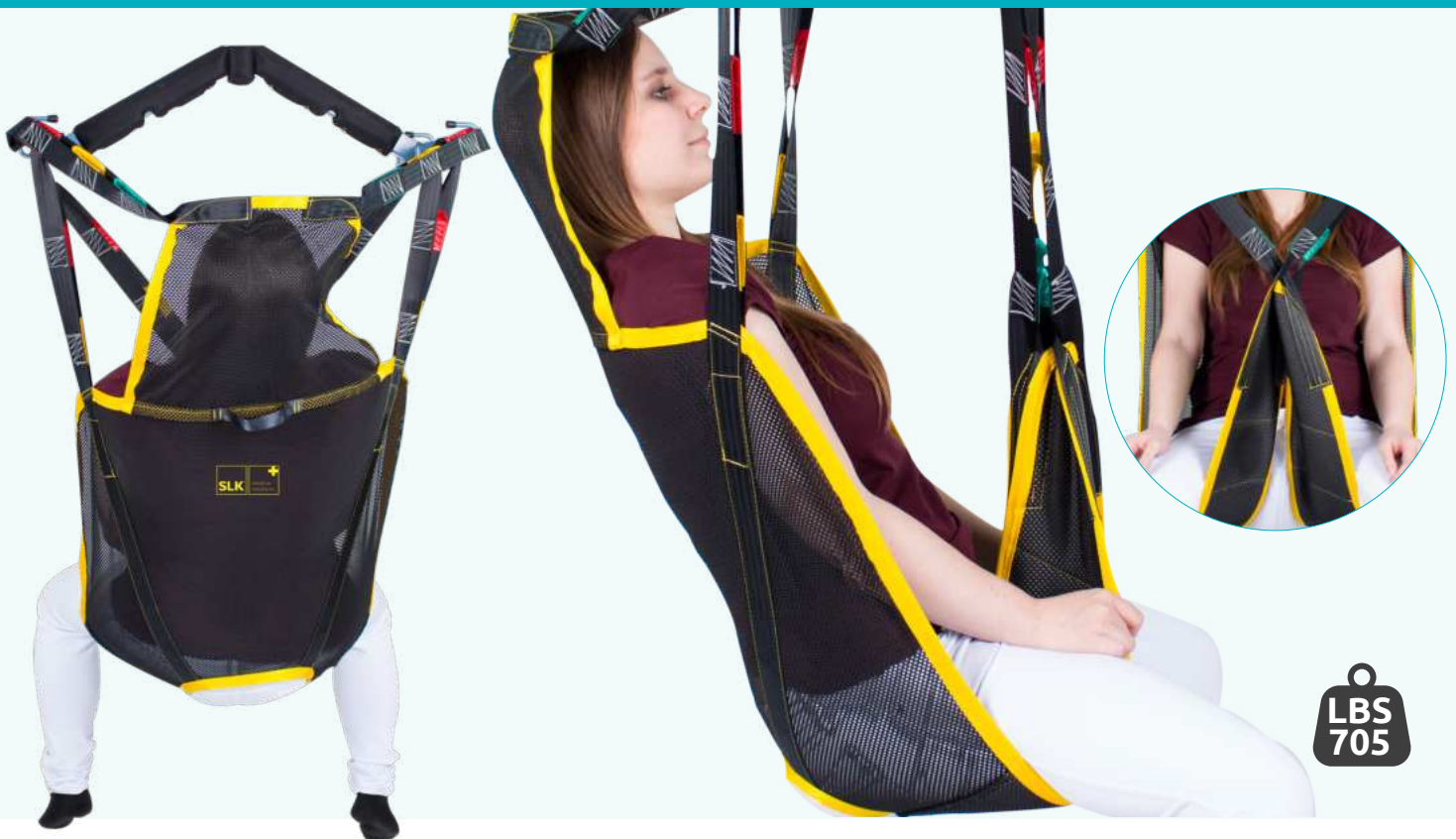

details

- max. patient weight: 320 kg (705 lbs)
- fast drying material
- the polyester-jersey-net allows a fast and easy water run-off
- ensures a pleasant skin climate during continuous use
- sling with integrated headrest for head stabilization
- also available in children's sizes (from size XXS)

sizes / article ID

KIDS	KIDS	
XXS	XS	S
5227	5228	5129
M	L	XL
5130	5131	5132
XXL		
5133		

Universal Hoists

- all SLK Universal Hoists
- also suitable for hoists of other producers according to our current declaration of conformity (download from our website)

optional

- SLK Extension Loops: 5719

material / service

- Polyester-Jersey
- washable up to 70 °C (158 °F)

warranty

- According to our current service guidelines

settlement item no: 22.40.04.0001

SLK Quick Transfer and Toilet Sling

Transfer and Toilet Sling for quick fastening and repositioning

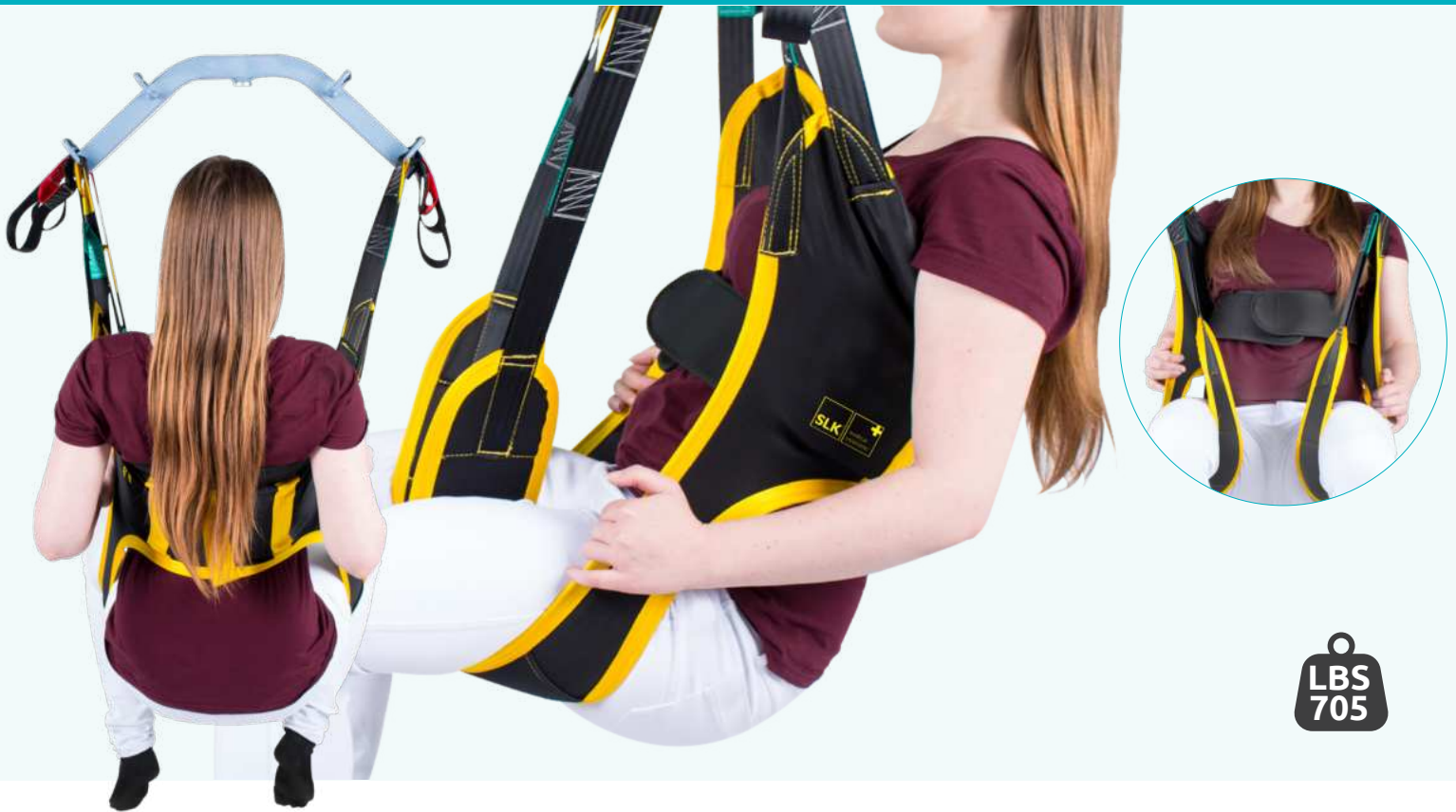

details

- max. patient weight: 320 kg (705 lbs)
- easy and quick to fasten and loose
- with back support and chest loop
- with larger cutout for the buttocks
- ensures a pleasant skin climate during continuous use
- also available in children's sizes (from size XXS)

sizes / article ID

KIDS

XXS

5219

KIDS

XS

5220

S

5134

M

5135

L

5136

XL

5137

Universal Hoists

- all SLK Universal Hoists
- also suitable for hoists of other producers according to our current declaration of conformity (download from our website)

optional

- SLK Adjustable Headrest Reinforced: 5138
- SLK Extension Loops: 5719

material / service

- Polyester-Jersey
- washable up to 70 °C (158 °F)

warranty

- According to our current service guidelines

settlement item no: 22.40.04.0001

SLK Toilet Sling

Toilet Sling



details

- max. patient weight: 320 kg (705 lbs)
- quick to put on and put off
- with larger cutout for the buttocks
- ensures a pleasant skin climate during continuous use

sizes / article ID

S 5139	M 5140	L 5141
XL 5142	XXL 5143	3XL 5206
4XL 5207		

Universal Hoists

- all SLK Universal Hoists
- also suitable for hoists of other producers according to our current declaration of conformity (download from our website)

optional

- SLK Adjustable Headrest Reinforced: 5138
- SLK Extension Loops: 5719

material / service

- Polyester-Jersey
- washable up to 70 °C (158 °F)

warranty

- According to our current service guidelines

settlement item no: 22.40.04.0001

SLK Hammock Universal Sling

Hammock Cut Sling for general application



details

- max. patient weight: 320 kg (705 lbs)
- high pressure relief for the patient
- specially developed for leg amputees
- ensures a pleasant skin climate during continuous use

sizes / article ID

S 5144	M 5145	L 5146
XL 5147	XXL 5148	3XL 5200
4XL 5201		

Universal Hoists

- all SLK Universal Hoists
- also suitable for hoists of other producers according to our current declaration of conformity (download from our website)

optional

- SLK Velcro Headrest: 5118
- SLK Extension Loops: 5719

material / service

- Polyester-Jersey
- washable up to 70 °C (158 °F)

warranty

- According to our current service guidelines

settlement item no: 22.40.04.0001

SLK Hammock Bathroom Sling

Hammock Cut Sling for general application in the bathroom

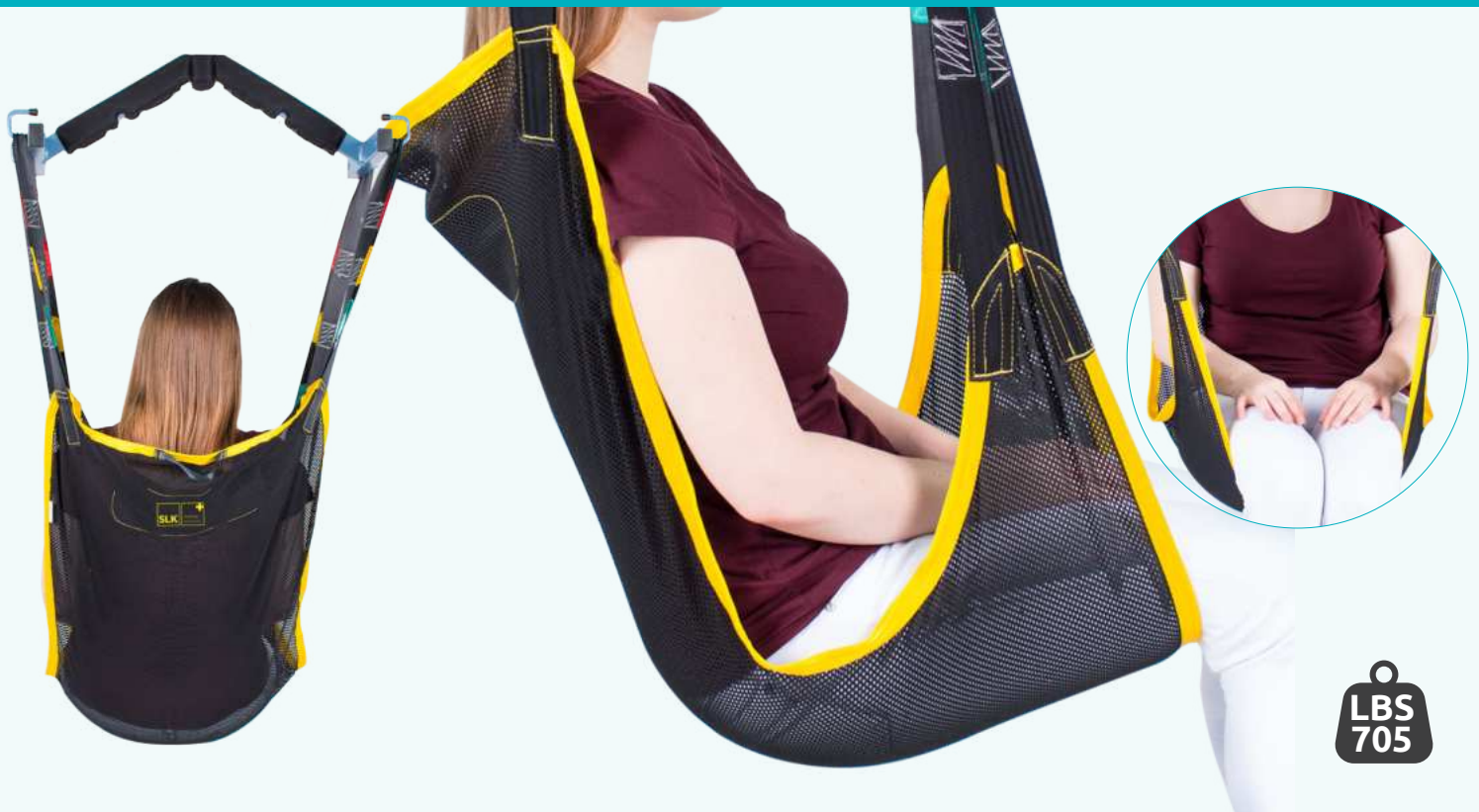

details

- max. patient weight: 320 kg (705 lbs)
- high pressure relief for the patient
- specially developed for leg amputees
- for transfer to bathtub, shower and pool
- ensures a pleasant skin climate during continuous use

sizes / article ID

S 5149	M 5150	L 5151
XL 5152	XXL 5153	3XL 5202
4XL 5203		

Universal Hoists

- all SLK Universal Hoists
- also suitable for hoists of other producers according to our current declaration of conformity (download from our website)

optional

- SLK Velcro Headrest: 5118
- SLK Extension Loops: 5719

material / service

- Polyester-Jersey
- washable up to 70 °C (158 °F)

warranty

- According to our current service guidelines

settlement item no: 22.40.04.0001

SLK Hammock Seat Pan Sling

Seat Pan Sling for remaining in the wheelchair

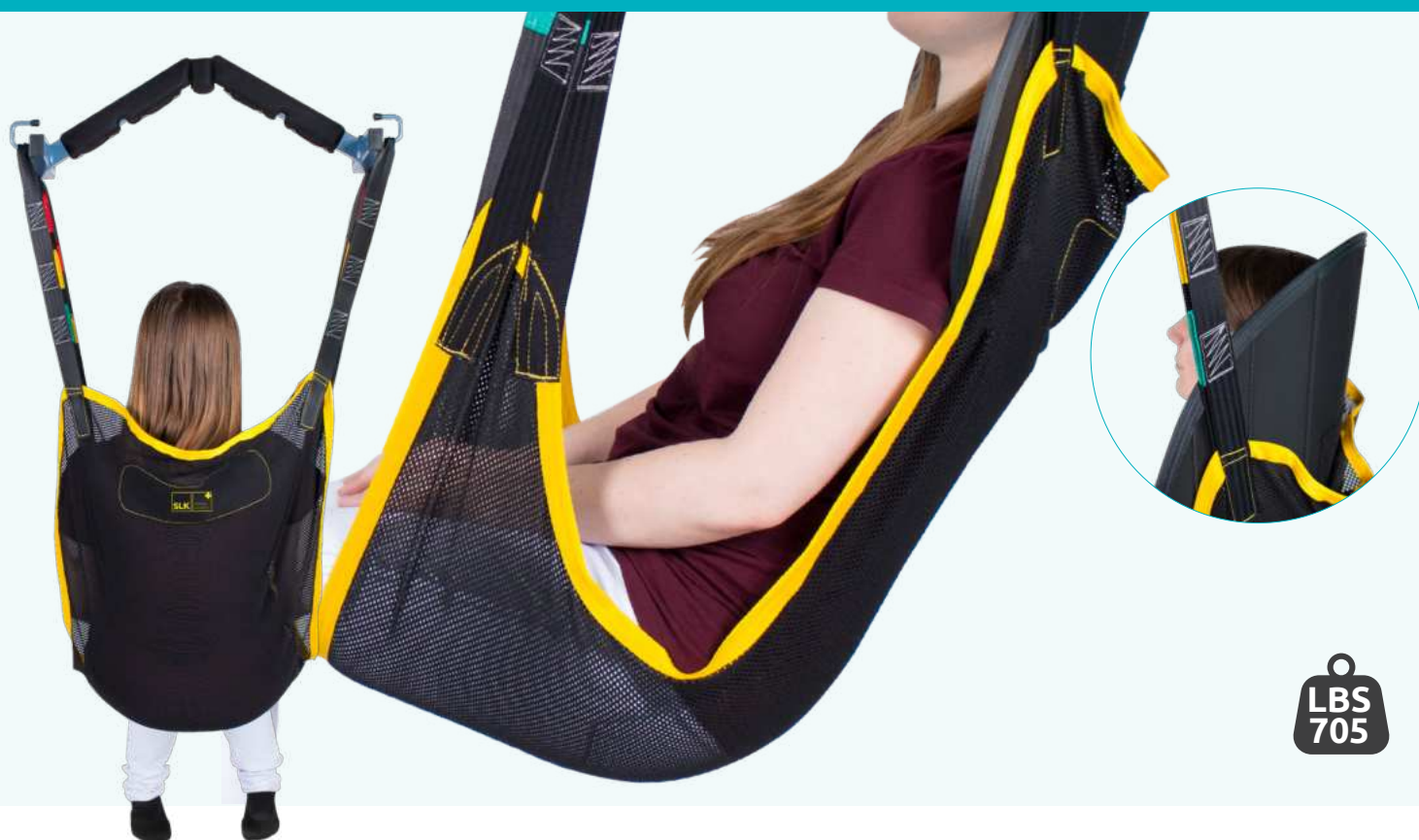

details

- max. patient weight: 320 kg (705 lbs)
- supple fabric, adjusting to the contours of the seat shell
- no seams or loops in the back and buttocks area
- ensures a pleasant skin climate during continuous use
- also available in children's sizes (from size XXS)

sizes / article ID

KIDS		KIDS
XXS 5223	XS 5224	S 5154
M 5155	L 5156	XL 5157
XXL 5158	3XL 5204	4XL 5205

Universal Hoists

- all SLK Universal Hoists
- also suitable for hoists of other producers according to our current declaration of conformity (download from our website)

optional

- SLK Velcro Headrest: 5118
- SLK Extension Loops: 5719

material / service

- Polyester-Jersey
- washable up to 70 °C (158 °F)

warranty

- According to our current service guidelines

settlement item no: 22.40.04.0001

SLK Comfort Lying Sling

Lying Transfer Sling for almost lying transport

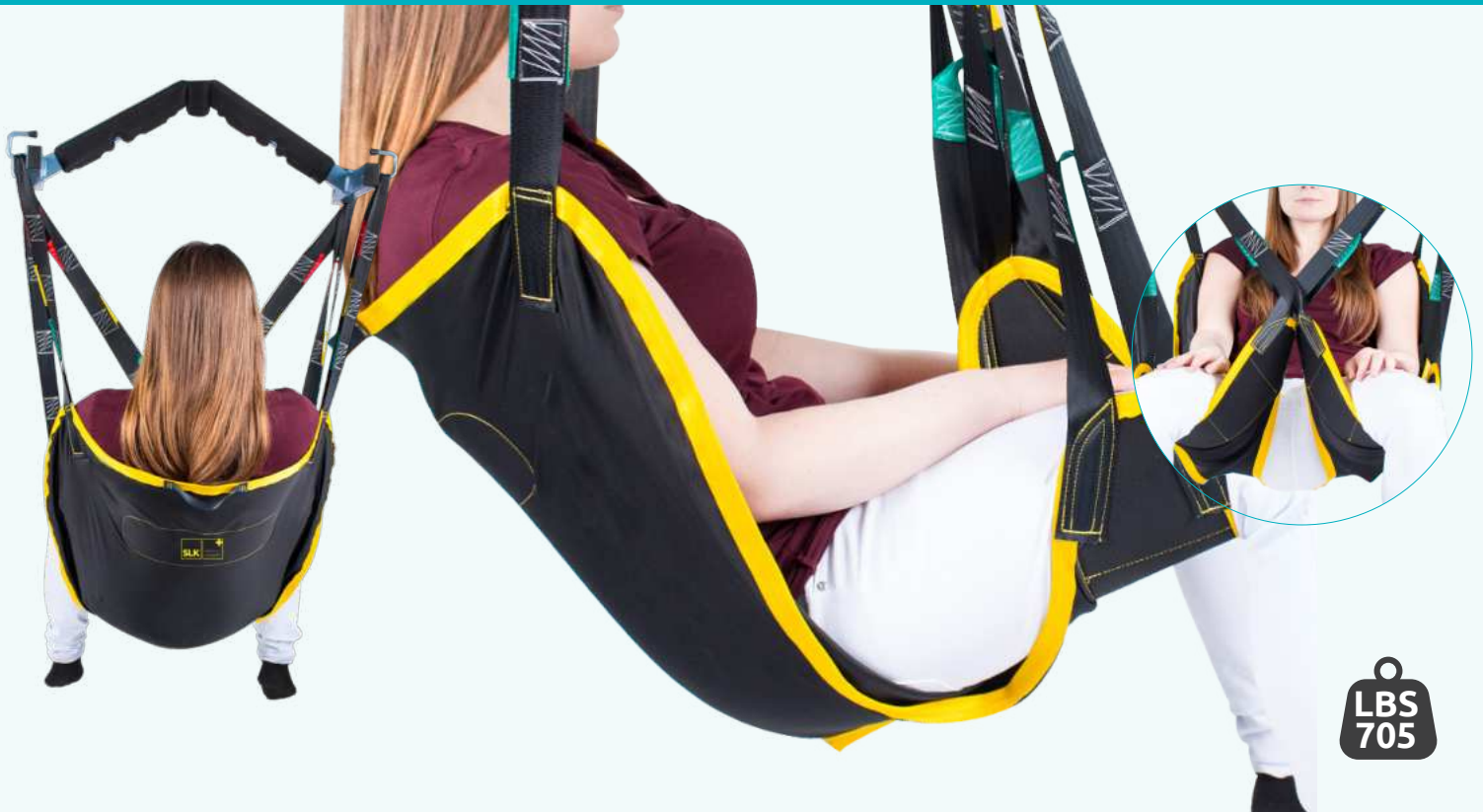

details

- max. patient weight: 320 kg (705 lbs)
- application with adjustable headrest recommended
- ensures a pleasant skin climate during continuous use

sizes / article ID

S 5159	M 5160	L 5161
XL 5162	XXL 5163	

Universal Hoists

- all SLK Universal Hoists
- also suitable for hoists of other producers according to our current declaration of conformity (download from our website)

optional

- SLK Velcro Headrest: 5118
- SLK Extension Loops: 5719

material / service

- Polyester-Jersey
- washable up to 70 °C (158 °F)

warranty

- According to our current service guidelines

settlement item no: 22.40.04.0001

SLK Comfort Lying Bathroom Sling

Lying Transfer Sling for almost lying transport



details

- max. patient weight: 320 kg (705 lbs)
- high pressure relief for the patient
- specially developed for leg amputees
- for transfer to bathtub, shower and pool
- ensures a pleasant skin climate during continuous use

sizes / article ID

S 5164	M 5165	L 5166
XL 5167	XXL 5168	

Universal Hoists

- all SLK Universal Hoists
- also suitable for hoists of other producers according to our current declaration of conformity (download from our website)

optional

- SLK Velcro Headrest: 5118
- SLK Extension Loops: 5719

material / service

- Polyester-Jersey
- washable up to 70 °C (158 °F)

warranty

- According to our current service guidelines

settlement item no: 22.40.04.0001

SLK Back-Fix Sling

Universal Sling

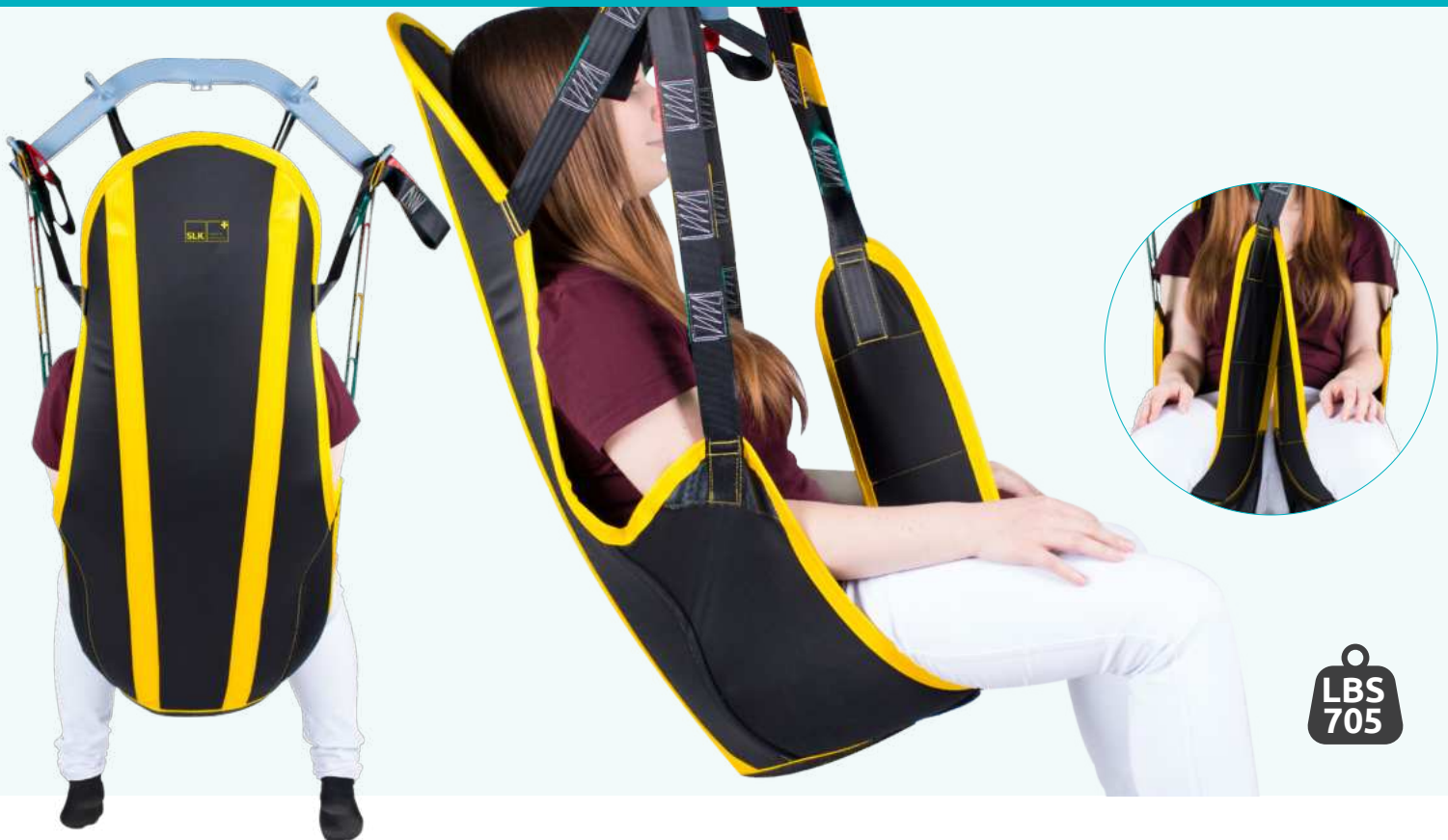

details

- max. patient weight: 320 kg (705 lbs)
- with reinforced back and integrated headrest
- ensures a pleasant skin climate during continuous use
- for patients whose back and head need to be extremely supported

sizes / article ID

S 5169	M 5170	L 5171
XL 5172		

Universal Hoists

- all SLK Universal Hoists
- also suitable for hoists of other producers according to our current declaration of conformity (download from our website)

optional

- SLK Extension Loops: 5719

material / service

- Polyester-Jersey
- washable up to 70 °C (158 °F)

warranty

- According to our current service guidelines

settlement item no: 22.40.04.0001

SLK Back-Fix Bathroom Sling

Bathing Sling



details

- max. patient weight: 320 kg (705 lbs)
- with reinforced back and integrated headrest
- ensures a pleasant skin climate during continuous use
- for transfer to bathtub, shower and pool
- for patients whose back and head need to be extremely supported

sizes / article ID

S 5173	M 5174	L 5175
XL 5176		

Universal Hoists

- all SLK Universal Hoists
- also suitable for hoists of other producers according to our current declaration of conformity (download from our website)

optional

- SLK Extension Loops: 5719

material / service

- Polyester-Jersey
- washable up to 70 °C (158 °F)

warranty

- According to our current service guidelines

settlement item no: 22.40.04.0001

SLK Maxi Sling

Universal Sling for bariatric patients



details

- max. patient weight: 320 kg (705 lbs)
- with integrated headrest
- ensures a pleasant skin climate during continuous use
- extra large sizes

sizes / article ID

XXL
5177

3XL
5178

4XL
4XL

Universal Hoists

- all SLK Universal Hoists
- also suitable for hoists of other producers according to our current declaration of conformity (download from our website)

optional

- SLK Extension Loops: 5719

material / service

- Polyester-Jersey
- washable up to 70 °C (158 °F)

warranty

- According to our current service guidelines

settlement item no: 22.40.04.0001

SLK Active Sling

Raising Sling for dual- and upward pulling Active Hoists



details

- max. patient weight: 320 kg (705 lbs)
- padded sling supporting raising motion
- additional abdominal belt for greater safety
- high wearing comfort

sizes / article ID

S 5100	M 5101	L 5102
XL 5103	XXL 5104	

Active Hoists

- all SLK Active Hoists
- also suitable for hoists of other producers according to our current declaration of conformity (download from our website)

optional

- SLK Extension Loops: 5719

material / service

- Polyester-Jersey
- washable up to 70 °C (158 °F)

warranty

- According to our current service guidelines

settlement item no: 22.40.04.0001

SLK Special Active Sling

Raising Sling with buttocks support for upward pulling Active Hoists



details

- max. patient weight: 320 kg (705 lbs)
- padded sling ensuring a safe and comfortable feeling while getting up
- additional buttocks belt for greater safety

sizes / article ID

S	M	L
5105	5106	5107

Active Hoists

- all SLK Active Hoists
- also suitable for hoists of other producers according to our current declaration of conformity (download from our website)

optional

- SLK Extension Loops: 5719

material / service

- Polyester-Jersey
- washable up to 70 °C (158 °F)

warranty

- According to our current service guidelines

settlement item no: 22.40.04.0001

SLK Special Active Sling with Seat Swing

Raising Sling for upward pulling Active Hoists



details

- max. patient weight: 320 kg (705 lbs)
- padded sling ensuring a safe and comfortable feeling while getting up

sizes / article ID

S 5188	M 5189	L 5190
XL 5191	XXL 5192	

Active Hoists

- all SLK Active Hoists
- also suitable for hoists of other producers according to our current declaration of conformity (download from our website)

optional

- SLK Extension Loops: 5719

material / service

- Polyester-Jersey
- washable up to 70 °C (158 °F)

warranty

- According to our current service guidelines

settlement item no: 22.40.04.0001

slings
size chart / overview

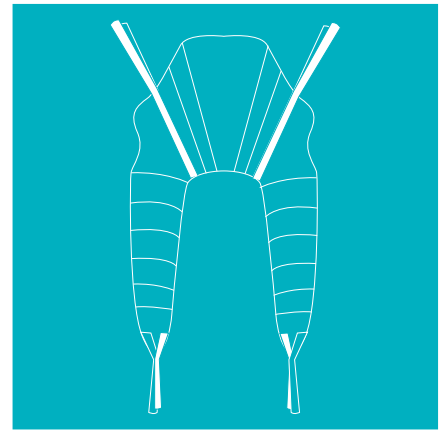
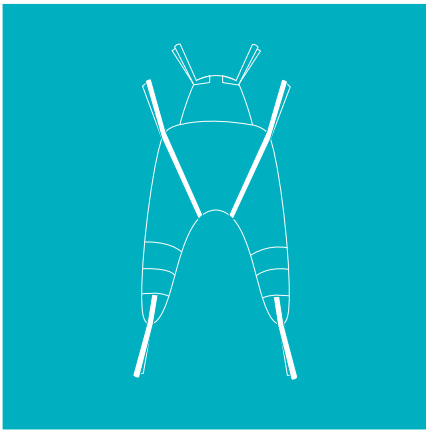

Body height in cm

Weight in kg

	80	90	100	110	120	130	140	150	160	170	180	190	200	210
15	KIDS XXS	KIDS XXS	KIDS XXS	KIDS XXS										
20	KIDS XXS	KIDS XXS	KIDS XS	KIDS XS	KIDS XS	KIDS XS								
25	KIDS XS	KIDS XS	KIDS XS	KIDS XS	KIDS XS	KIDS XS	KIDS XS							
30			S	S	S	S	S	S	M	M				
40			S	S	S	S	S	S	M	M	M			
50			M	M	M	M	S	S	M	M	M	M	M	M
60			M	M	M	M	M	M	M	M	M	M	M	M
70			M	M	M	M	M	M	L	L	L	M	M	M
80				L	L	L	L	L	L	L	L	L	L	L
90				L	L	L	L	L	L	L	L	L	L	L
100								L	L	L	L	L	L	L
110								XL	XL	XL	XL	L	L	L
120								XXL	XL	XL	XL	XL	XL	XL
130								XXL	XL	XL	XL	XL	XL	XL
140								XXL	XL	XL	XL	XL	XL	XL
150								XXL	XXL	XXL	XXL	XXL	XXL	XXL
160								XXL	XXL	XXL	XXL	XXL	XXL	XXL
170								XXL	XXL	XXL	XXL	XXL	XXL	XXL
180								XXL	XXL	XXL	XXL	XXL	XXL	XXL
190									XXL	XXL	XXL	XXL	XXL	XXL
200									XXL	XXL	XXL	XXL	XXL	XXL
210									XXL	XXL	XXL	3XL	3XL	3XL
220									3XL	3XL	3XL	3XL	3XL	3XL
230									3XL	3XL	3XL	3XL	3XL	3XL
240									3XL	3XL	3XL	3XL	3XL	3XL
250									3XL	3XL	3XL	3XL	3XL	3XL
260									3XL	4XL	4XL	3XL	3XL	3XL
270									3XL	4XL	4XL	4XL	4XL	4XL
280										4XL	4XL	4XL	4XL	4XL
290										4XL	4XL	4XL	4XL	4XL
300										4XL	4XL	4XL	4XL	4XL
310										4XL	4XL	4XL	4XL	4XL
320										4XL	4XL	4XL	4XL	4XL

SLK Velcro Headrest

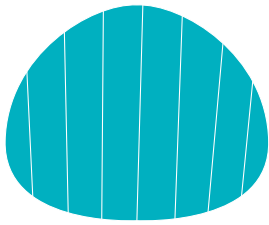

SLK Adjustable Headrest Reinforced

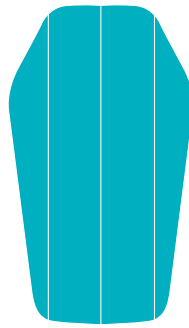

SLK Toilet Sling

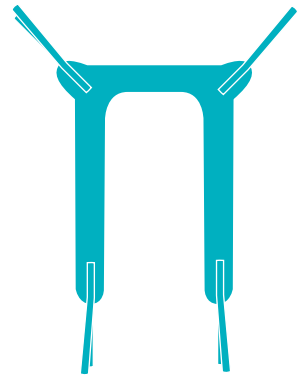

SLK Calf Band



SLK Special Active Sling



SLK Special Active Sling with Seat Swing



SLK Quick Transfer and Toilet Sling

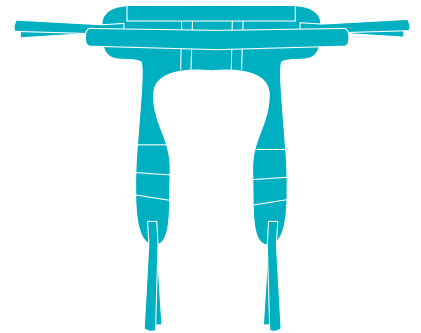

SLK Active Sling



SLK Seat Swing

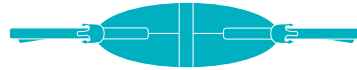

SLK Universal Sling

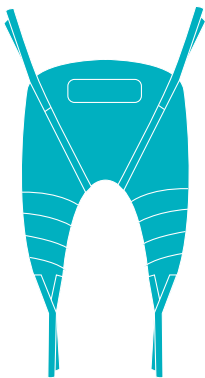

SLK Universal Sling with Headrest

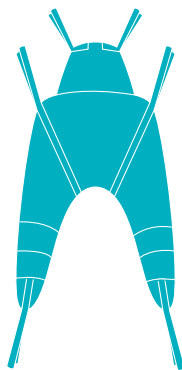

SLK Back-Fix Sling

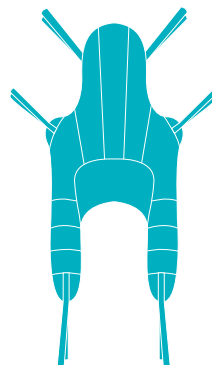

SLK Maxi Sling

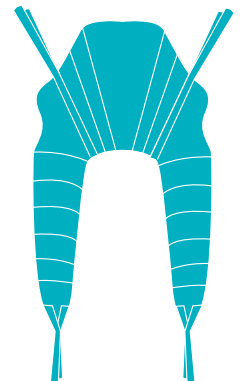

SLK Hammock Seat Pan Sling

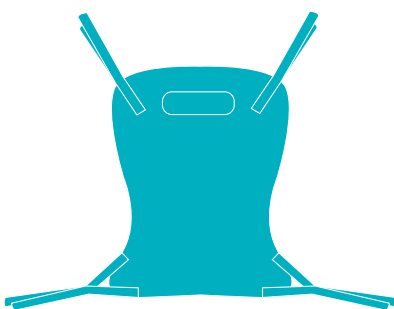

SLK Hammock Universal Sling

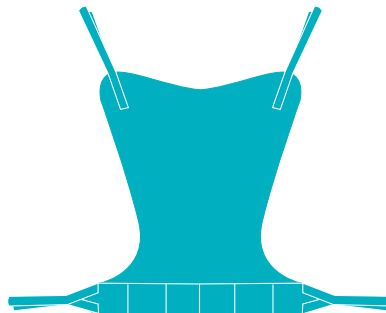

SLK Comfort Lying Sling

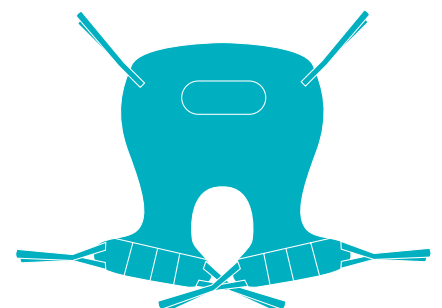

accessories
hoist accessories

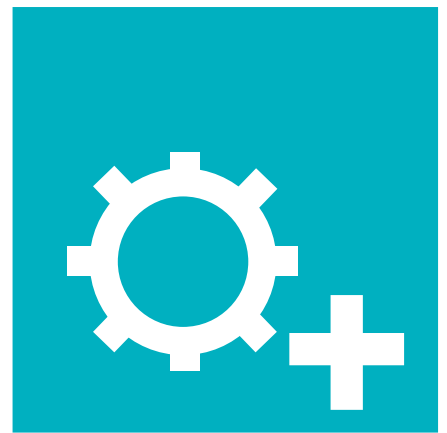
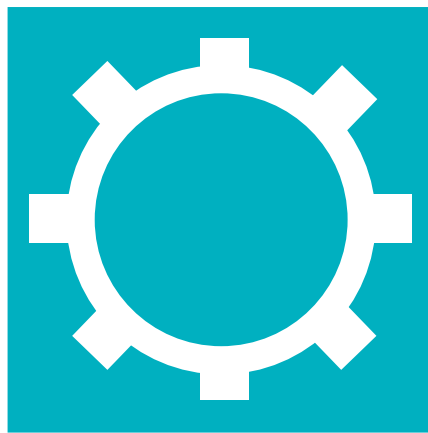
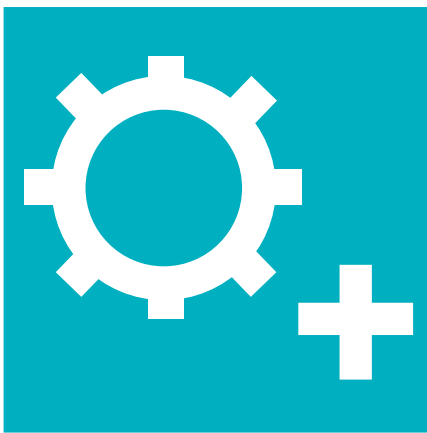

SLK Hoist Scales

Hoist Scales for all SLK Universal Hoists



SLK Hoist Scale

To weigh a person the SLK Hoist Scale can be connected directly to the Universal Hoist. It is quick and easy to integrate in everyday care. The patient scale is designed for a weight capacity up to 300 kg (660 lbs) and therefore also suitable for bariatric patients.

- including adapter for all SLK Universal Hoists
- Use of hoists other manufacturers on request

article-ID 5186



SLK Calibrated Hoist Scale

The SLK Calibrated Hoist Scale is first time calibrated ex works and therefore appropriate for medical purposes. To weigh a person it can be directly connected to the Universal Hoist. It is quick and easy to integrate in everyday care. The patient scale is designed for a weight capacity up to 300 kg (660 lbs) and therefore also suitable for bariatric patients.

- including adapter for all SLK Universal Hoists
- Use of hoists other manufacturers on request

article-ID 5183

SLK Carry Charge Base

SLK Charger Propulsion system Typ I + Typ II



The SLK Charging Station can be used to charge the batteries of Universal Hoists can be charged regardless of the Hoist's location. This can be used as a wall charging station or as a table charging used as a tabletop charging station. Use in stationary facilities is recommended, as the Hoist is always ready for use with an additional ready for use at any time.

- suitable for SLK Carry Productfamily, SLK Multy Hybrid Hoist
- Charger optionally available
- Delivery without battery

Typ I: article-ID 8634
Typ II: article-ID 8454

SLK Charging Station with Charger Propulsion system Typ I + Typ II



The SLK Charging Station can be used to charge the batteries of Universal Hoists can be charged regardless of the Hoist's location. This can be used as a wall charging station or as a table charging used as a tabletop charging station. Use in stationary facilities is recommended, as the Hoist is always ready for use with an additional ready for use at any time.

- suitable for SLK Carry Productfamily, SLK Multy Hybrid Hoist
- Delivery without battery

Typ I: article-ID 8641
Typ II: article-ID 8390

SLK Wall-mounted Charging Station UMEC Propulsion system

The SLK Wall-mounted Charging Station can be used to charge Universal Hoist batteries can be charged regardless of the hoists location. Use in stationary facilities is recommended, since with an the hoist is always ready for use with an additional ready for use at any time.

- suitable for all SLK Universal Hoists (except SLK Carry's + Multy's)
- Delivery without battery

article-ID 5182

SLK Spreader Bar

SLK 2-Point and 4-Point Spreader Bar



■ width: 59 cm (23.2")



SLK 2-Point Spreader Bar

The SLK 2-Point Spreader Bar allows a particularly comfortable transport feeling. Slings can not be unintentionally released due to its spring lock.

article-ID 8053 (telegrey)

■ for SLK Carry 185 Classic / e

article-ID 8054 (silver)

■ for SLK Carry 185 Pro, Pro L, SLK Multy Universal

and the electrically spreadable models

article-ID 8689 (telegrey)

■ for SLK Carry Compact Universal Hoist



■ width: 60 cm (23.6")



SLK 4-Point Spreader Bar X

The SLK 4-Point Spreader Bar X allows a particularly comfortable transport feeling. Slings can not be unintentionally released due to its spring lock.

article-ID 8060 (silver)

■ for SLK Carry Productfamily, SLK Multy Universal

and the electrically spreadable models



■ width: 57 cm (22.4")



SLK 4-Point Spreader Bar H

The SLK 4-Point Spreader Bar H allows a particularly comfortable transport feeling. It is especially suitable for obese patients. Slings can not be unintentionally released due to its spring lock.

We recommend the use of the SLK 4-Point Spreader Bar H inter alia to:

- obese patients
- sensitive patients
- patients which tend to stretch spastik



■ width: 52 cm (20.5")



article-ID 8064 (silver)

■ for SLK Carry Productfamily, SLK Multy Universal

and the electrically spreadable models

article-ID 8095 (telegrey)

■ specially for SLK Carry Compact Universal Hoist

SLK 8-Point Spreader Bar

Tareable 8-Point Spreader Bar for gentle Horizontal transfer



SLK 8-Point Lying Sling



Hook mount with spring lock



The purpose of the SLK 8-Point Spreader Bar is to enable lifting and transferring of persons together with a lift system and an 8-point sling. The special feature of the SLK 8-Point Spreader Bar is that this transfer of patients is performed in the lying position.

As suitable Universal Hoist systems we name the SLK Carry and Multy Universal Hoist.

details

- Tareable 8-Point Spreader Bar for gentle Horizontal transfer
- Ideal for transferring comatose and pain sensitive patients
- Can be used in conjunction with 8-Point Lying Sling

optional

- SLK Velcro Headrest: 5118

scope of delivery

- SLK 8-Point Spreader Bar
- 1 x instruction manual 8303

article-ID

8062 (Maximum load 185 kg/407 lbs for SLK Carry 185 Productfamily and SLK Multy Universal)

8063 (Maximum load 275 kg/606 lbs)

8065 (Maximum load 300 kg/660 lbs for SLK Flyer XL)

8059 (Maximum load 400 kg/880 lbs)

5699 (suitable SLK 8-Point Lying Sling)

technical data / dimensions

- length: 161 cm (63")
- width: 74,5 cm (29")
- height: 29 cm (11")
- weight: 17 kg - 19 kg (37" - 42")
(depending on version)

SLK Hoist Accessories



SLK Impact Protector for Lifting Arm

The SLK Impact Protector for Lifting Arm reduces Injury risks.

- suitable for all SLK Universal Hoists
- can also be mounted on Universal Hoists from other manufacturers

article-ID 5464



SLK Velcro Headrest

The SLK Velcro Headrest is optional for supporting the patient's head and neck area. For ideal SLK 4-Point Spreader Bar is recommended for ideal use.

- suitable for Slings with matching device

article-ID 5118



SLK Adjustable Headrest Reinforced

The Adjustable Headrest Reinforced is optional to support the patient's head, neck and back. For ideal application a SLK 4-Point Spreader Bar is recommended.

- suitable for SLK Toilet Sling and SLK Quick Transfer and Toilet Sling

article-ID 5138

SLK Hoist Accessories



SLK Extension Loops for the Hoist Slings

The SLK Extension Loops enable you to extend the to extend the sling loops of suitable SLK Slings in order to quickly and easily adapt them to the different needs of patients' needs. They are made of extremely tear-resistant webbing and are easy to attach to the belt loops of the SLK Slings. and are designed for SLK Slings on Hoists.

By lengthening the Extension Loops, the following goals can be the following goals can be achieved:

- Increasing the free space of the patient to the transport bar
 - easier hooking of the belt loops on the transport bar
 - especially when picking up the patient from the floor
 - Extension of the leg loops in order to achieve a more upright position or to make the angle of the position more position more open (in the hip)
 - Effective extension, after attachment to SLK Slings approx. 18 cm
- suitable for all SLK Slings
 - standard: DIN EN ISO 10535:2007-04
 - length: 24 cm (folded)

article-ID 5719

#workgreen

SLK Weight Test Trolley up to 220 kg

for maximal load test as a part of the hoist maintenance



without load



suspended condition

details

- max. load: 220 kg (485 lbs)
- for the functional testing of Universal Hoists with maximum load according to EN 10535 (appendix B1)
- adapt to your patient hoist the height of the stop can be simply determined by the weight trolley, therefore the whole lifting area is covered during the test
- suitable for almost all common hoists

material / service

- powder coated steel
- braked castors 75 ø mm (3"), ball bearing

warranty

- According to our current service guidelines

scope of delivery

- frame with castors **without weights**
- drawbar
- shackles
- bott with sl-fastener

SLK Weight Test Trolley up to 440 kg

for maximal load test as a part of the hoist maintenance



MADE
IN
GERMANY



details

- max. load: 440 kg (970 lbs)
- for the functional testing of Universal Hoists with maximum load according to EN 10535 (appendix B1)
- adapt to your patient hoist the height of the stop can be simply determined by the weight trolley, therefore the whole lifting area is covered during the test
- suitable for almost all common hoists

material / service

- powder coated steel
- braked castors 75 ø mm (3"), ball bearing

warranty

- According to our current service guidelines

scope of delivery

- 2 frames with castors **without weights**
- drawbar
- 2 shackles
- 2 Slings
- bott with sl-fastener

article-ID 5474



■ MADE
■ IN
■ GERMANY



Products

- alternating pressure systems for decubitus prophylaxis and therapy
- intermittent pneumatic compression with 12 chamber garments for different fields of applications
- hoists for patients with mobility restrictions due to illness or disability

Service

- fast delivery of products
- safe and timely chemothermic cleaning and testing of anti-decubitus systems according to a validated procedure
- regular inspection of the cleaning by an internationally recognized hygiene institute
- cleaned systems are packed in breathable sanitary bags, sealed and shipped in new boxes
- maintenance and repair of SLK products
- cleanings with maintenance and leakage test according to DIN EN 62353
- repairs of external system on request
- high security for re-use

Training

- SLK offers advanced product training programs as well as trainings about bedsores for physicians, nursing personnel, hospitals and / or the medical service employees and others
- we offer training for our partners on the topic of wound treatment



Wellell Group

SLK Vertriebsgesellschaft mbH
Am Herdicksbach 18
45731 Waltrop - Germany

telephone: +49 (0) 2309 - 91545 - 0
telefax: +49 (0) 2309 - 91545 - 999
e-mail: info@slk-gmbh.de
internet: www.slk-gmbh.de
Revision: 002 - 8/2024

 @SLK Medizintechnik

 [slk_medizintechnik](https://www.instagram.com/slk_medizintechnik)